

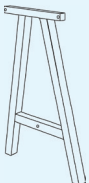









### NOTES:

To achieve the best results with the assembly of our bar, we strongly recommend using wood glue on all screws (apply to full length of screw) and an impact drill gun.

### PARTS:

A	B	C	D	E	F	G	H	I	J	TOOL	TOOL
							 HEX 4MM	 HEX 5MM	 HEX 4MM L 40MM	 IMPACT DRILL	 WOOD GLUE
<b>X2</b>	<b>X2</b>	<b>X1</b>	<b>X1</b>	<b>X2</b>	<b>X12</b>	<b>X4</b>	<b>X4</b>	<b>X8</b>	<b>X14</b>	<b>NOT INCLUDED</b>	<b>NOT INCLUDED</b>

### DIAGRAM:

#### STEP 1:

DO NOT TIGHTEN SCREWS UNTIL STEP 2 IS COMPLETE (ALLOWING ROOM FOR G).

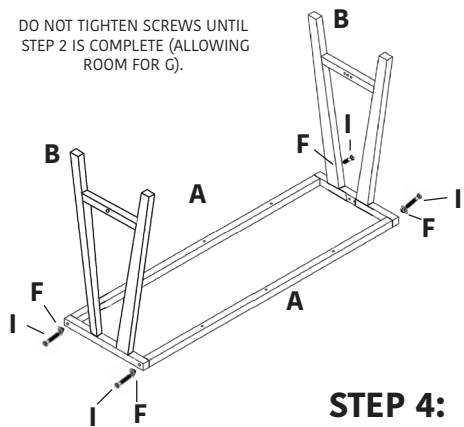

#### STEP 2:

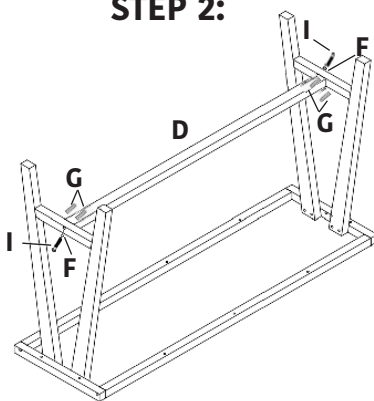

#### STEP 3:

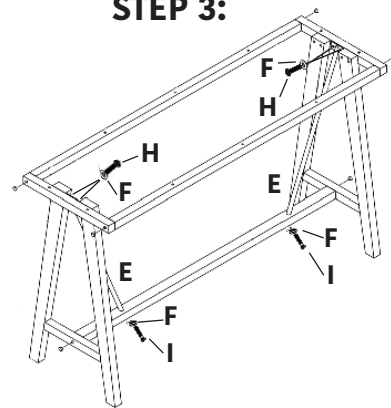

#### STEP 4:

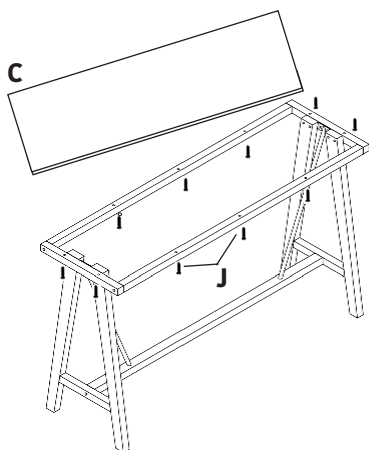

#### COMPLETE:

