

PHOENIX DINING CHAIR

eZ ASSEMBLY INSTRUCTIONS

NOTES:

To achieve the best results with the assembly of our chairs, we strongly recommend thread locking all screws (apply to full length of screw) using an impact drill gun and pvc gluing all dowels and plugs. Always take care when screwing into the frame.

PARTS:











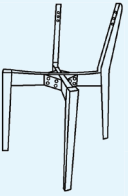

A	B	C	D	E	F	G	H	I	TOOL	TOOL	TOOL
											
X1	X1	X1	X4	X4	X8	X8	X2	X4	NOT INCLUDED	NOT INCLUDED	NOT INCLUDED

DIAGRAM:

STEP 1:



STEP 2:

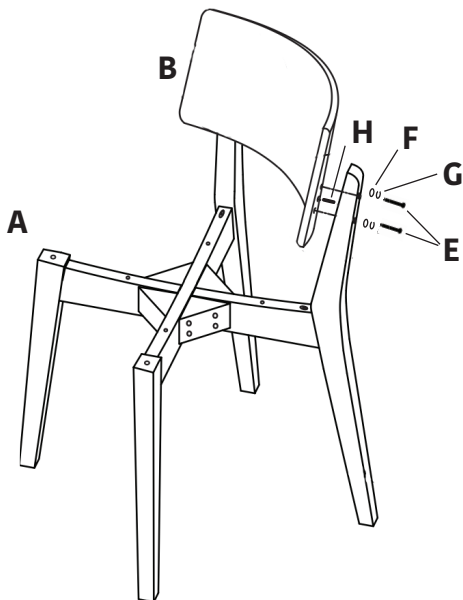
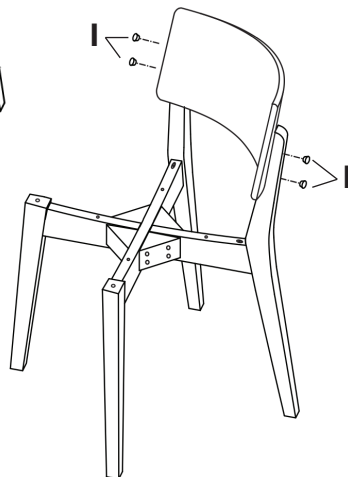

STEP 3:

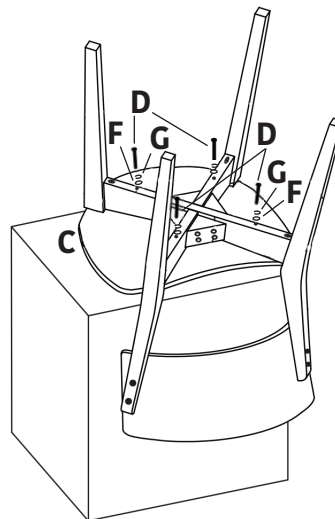

COMPLETE:

