

NOTES:

To achieve the best results with the assembly of our stool, we strongly recommend thread locking all screws (apply to full length of screw) and the use of an impact drill gun.

PARTS:







A	B	C	D	E	TOOL	TOOL
			 HEX HEAD 4MM	 HEX HEAD 4MM	 IMPACT DRILL	 THREAD LOCK
X1	X1	X1	X5	X2	NOT INCLUDED	NOT INCLUDED

DIAGRAM:

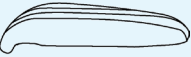
STEP 1:

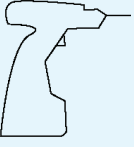

COMPLETE:

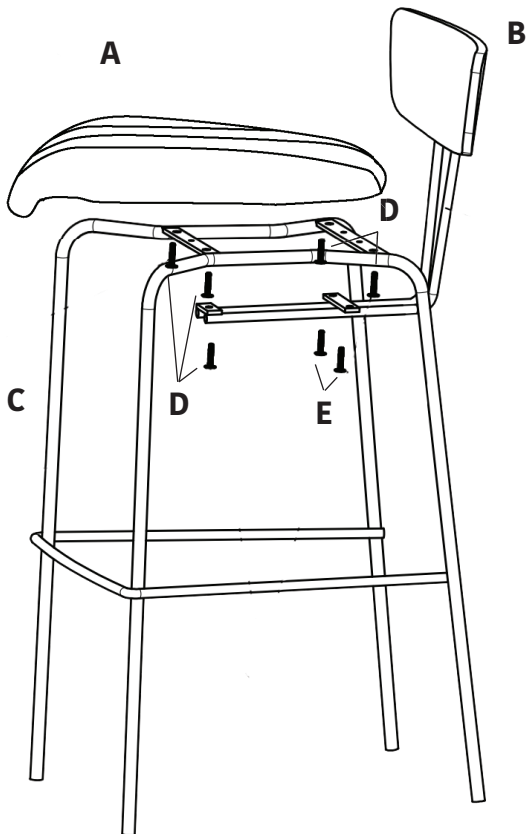